



**Installation:** hazardous areas - Zone 1 / 2 (Gases) - Zone 21 / 22 (Dusts)  
**Classification:** Group II - Category 2G 2D



**REFERENCE STANDARDS**

**Directive 2014/34/EU**

EXECUTION	<ul style="list-style-type: none"> <li>⊗ II 2 G Ex d IIC T6/T5 Gb</li> <li>⊗ II 2 D Ex tb IIIC T85°C/ T100°C Db</li> </ul>
RULES OF COMPLIANCE	EN/IEC 60079-0; EN/IEC 60079-1; EN/IEC 60079-31
EC Type-Examination Certificate	INERIS 04 ATEX 0076X
PROTECTION DEGREE	IP66
AMBIENT TEMPERATURE	-60°C ÷ +60°C
OTHER AVAILABLE CERTIFICATES	IECEx: IECEx INE 11.0033X INMETRO: CEPEL 13.2255X EAC: TC RU C-IT.BH02.B.00608 RUSSIAN MARINE CERTIFICATE (RMRS): 13.03520.315

**Mechanical characteristics**

Body	marine grade copper free aluminium light alloy
Cover	marine grade copper free aluminium light alloy
Screws	stainless steel
Gasket	NBR rubber sealing ring



**On Request Accessories:**

- External epoxy painting with colour on request
- Cable entries with different threads from standards

Technical Features

CODE	A [mm]	B [mm]	C [mm]	D [mm]	Ø E [mm]	F [mm]	G [mm]	G.1 [mm]	TEMPERATURE CLASS (GAS)	TEMPERATURE CLASS (DUSTS)	DETAIL
EFDC3D	145	295	147,5	120	9	1" NPT	145	125	T6 T5	T85°C T100°C	A
EFDC3T	145	425	130	120	9	1" NPT	145	125	T6 T5	T85°C T100°C	B

Reference details

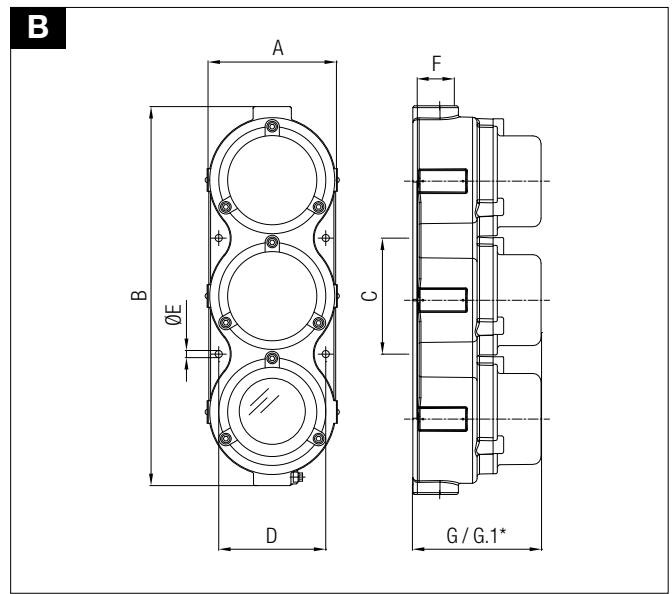
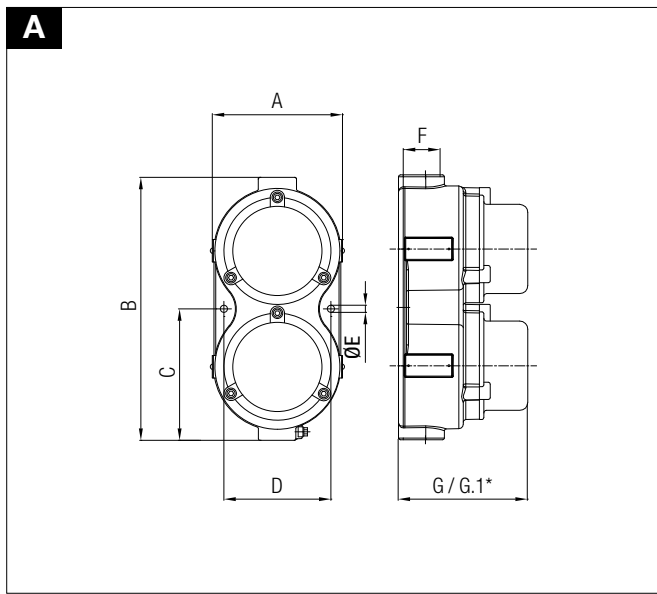

\*LOW LID, ONLY FOR GLASS WINDOW

Installation examples

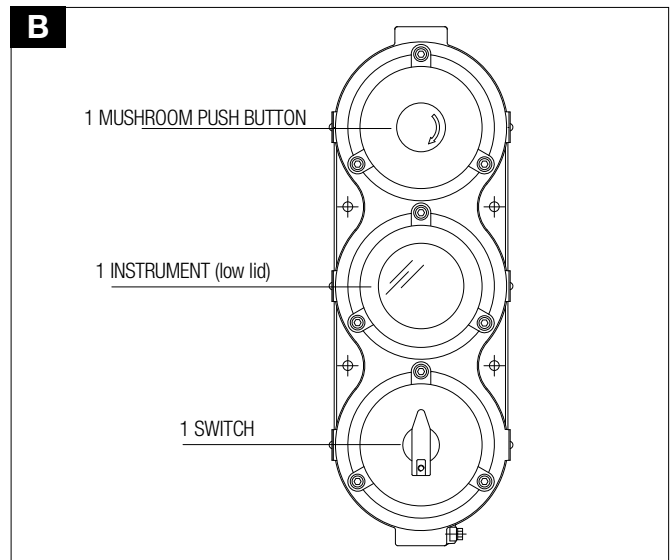
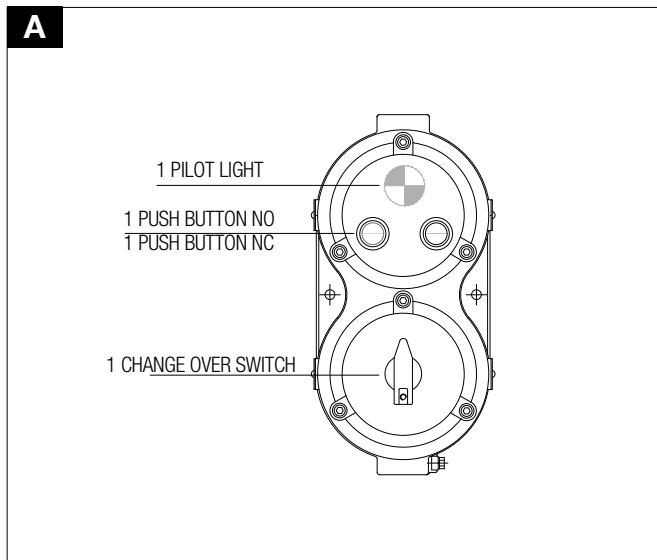

OPERATOR ARRANGEMENT:

ON EACH COVER IS POSSIBLE TO FIT THE FOLLOWING MATERIAL:

- 1 48x48 INSTRUMENT (low lid with glass)
- UP TO 3 PILOT LIGHTS (as EFDC...R, see bulletin 65)
- UP TO 3 PUSH BUTTON (as EFDC...R, see bulletin 65)
- 1 MUSHROOM PUSH BUTTON (as EFDC..., see bulletin 65)
- 1 SELECTOR SWITCH (as EFSC..., see bulletin 66)

REMARK:

Due to the development of the national and international specifications and of the technology, the above technical characteristics showed on this bulletin can be considered as binding on our confirmation only.